

CLEANFIT 

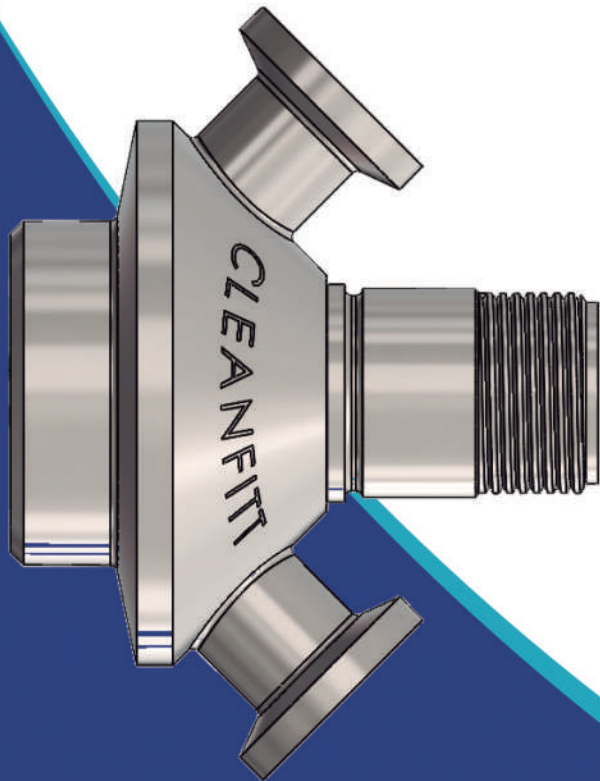

Válvula de amostragem estéril intercambiável

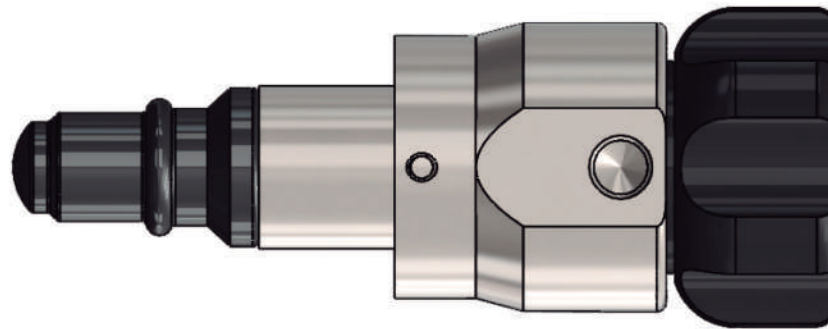

O sistema de amostragem estéril
da Stockval

Standard



Linha

Esterilizável com vapor ou CIP, apresenta design Coaxial com uma entrada dedicada para SIP e CIP

O design Standard da Cleanfitt é intercambiável com diversos sistemas disponíveis no mercado e possibilita amostragem higiênica e estéril pela possibilidade de limpeza química ou passagem de vapor pela válvula no local onde está instalada.

Fabricadas com materiais tipicamente utilizados nas indústrias higiênicas de todo o mundo, como aço inoxidável 316L e vedações de EPDM e PTFE, aprovados pela FDA e USP.

Diversos acabamentos de superfície em acordo com ASME BPE, inclusive eletropolimento, possibilitam as válvulas Standard da Cleanfitt apresentar performance exigida em aplicações desde alimentos e bebidas até farmacêuticas e biotecnologia.

Modelos e diâmetros disponíveis:

- S5 (ID 5 mm)
- S10 (ID 9 mm)
- S15 (ID 15 mm)
- S25 (ID 25 mm)

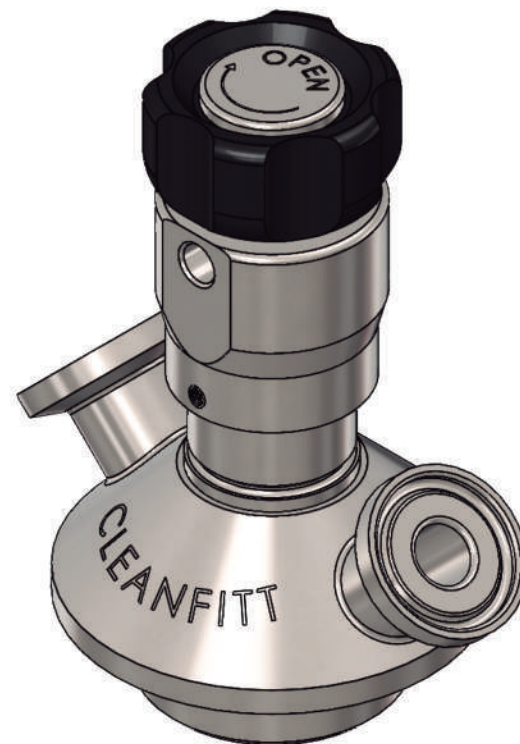

CLEANFITT 
O sistema de amostragem estéril da Stockval

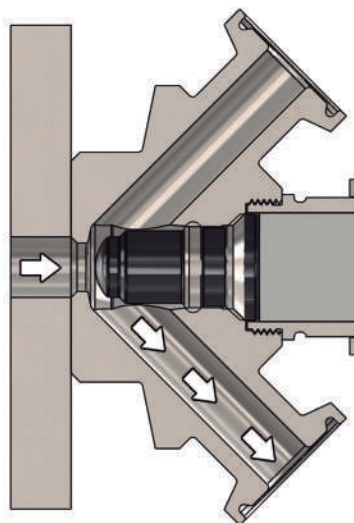

Amostragem

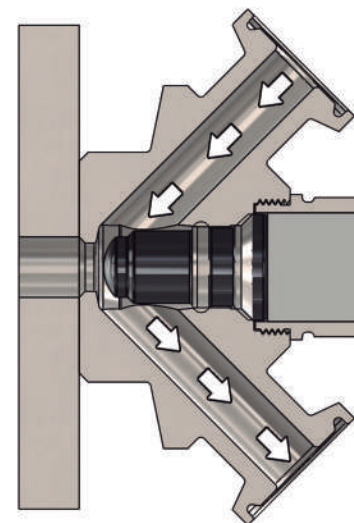
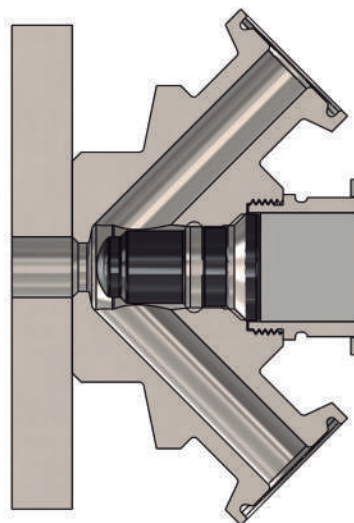

Esterilização



Válvula de amostragem Cleanfitt Standard S10

Esterilizável com vapor ou CIP, apresenta design Coaxial com uma entrada dedicada para SIP e CIP

A Cleanfitt Standard S10 é utilizada na grande maioria das aplicações de amostragem higiênica/estéril. O aprimoramento do design pela experiência com os mais diversos tipos de aplicações refinou o produto, formato e suas dimensões.

Projetada para amostrar produtos com viscosidades entre 0 e 1.000 cP com presença de partículas de até 3 mm de diâmetro, a S10 atende aos requisitos de quase todas as aplicações de amostras de líquidos, inclusive de produtos mais viscosos, apenas levando mais tempo para finalizar o ciclo de amostra (dependendo da pressão da linha).

Além da variedade de tipos de corpo e cabeça para as S10 também estão disponíveis três materiais diferentes de membranas: EPDM, Silicone e PTFE. Acessórios como engates rápidos para conexão das linhas de CIP e SIP e adaptadores também estão disponíveis.

Tipos de indústrias:

Cervejaria, laticínios, farmacêutica, biotecnologia.





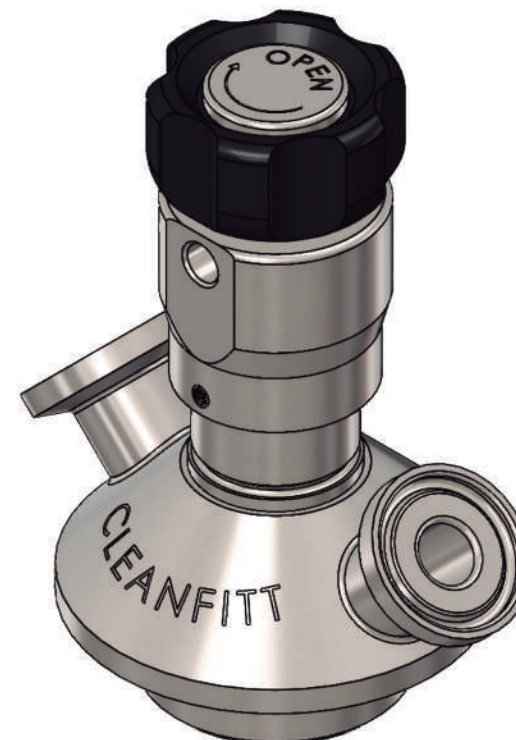













Aplicações típicas:

Produtos e ingredientes farmacêuticos, cerveja filtrada, cremes e loções, leite.



S10



CORPOS S 10	Corpos para solda				Corpos para uniões						
	Solda em tubo	Solda em tubo 1"	Solda em linha vertical	Solda em linha horizontal	Varivent Ø50	Varivent Ø68	Mini Clamp	Clamp 1" e 1-1/2"	Clamp 2"	Clamp 3"	
Engate rápido	 900001	 900011	 900027	 900028	 900008	 900009	 900036	 900021	 900003	 900004	
Tri-clamp 1/2"	 900006	 900010			 900020	 900013	 900039	 900025	 900026		
Solda 1/2"	 900007	 900019									



CABEÇAS S 10		Tipo TK Manípulo Giratório 0-10 bar (FFKM 0-6 bar)	Tipo TKA Manípulo Giratório (c/ micro acesso) 0-10 bar	Tipo RK Manípulo Removível 0-10 bar (FFKM 0-6 bar)	Tipo RKA Manípulo Removível (c/ micro acesso) 0-10 bar	Tipo TKS 0-12 bar
	Silicone	 910041	 910048	 910042	 910049	 910047
	EPDM	 910041E	 910048E	 910042E	 910049E	 910047E
	PTFE	 925541		 925542		 925547



ACESSÓRIOS S 10	Anéis	EPDM 60 x 3 100208 	SILICONE 7,1 X 1,6 200825 	SILICONE 10,3 X 2,4 300830 	SILICONE 10,3 X 2,4 300830E 										
	Membranas	SILICONE 930051 	EPDM 930052 	SILICONE MP 930251 	EPDM MP 930252 	PTFE 940055 									
	Rosca M16,5 x 1,5	STEEL CAP 960061 													
	Engate Rápido	PTFE OC 0.5 m 950002 	PTFE OCXTC 0.5m 950002.2 	PTFE OCXTC 0.5m 950003 	RUBBER CAP 950062 	COIL 950058 	OC PLUG 950061 	OC STEEL PIPE 950070 	OC HOSEBARB 3/8 950082 	OC TC 950083 	OC S10 W/ SS HP 950086 				
		OC W/ HB FOR PTFE 10/8 950091 	OC PTFE M16X1.5 950171 												
	Mini Tri-Clamp	CLAMP PTFE 10/8 950021 	PTFE TC 0.5m 950004 	PTFE TC 1.0m 9500045 											
	Para Cabeças de Válvulas		BUSHING 900149 	TOMMY BAR 960018 											
	Diversos	TUBO PTFE 10/8 950047 													

Standard



Valvula de amostragem Standard Cleanfitt S5

CLEANFITT 
O sistema de amostragem estéril da Stockval

A Cleanfitt Standard S5 é a menor válvula da linha Cleanfitt Standard.

Projetada para amostrar produtos de baixas viscosidades, entre 0 e 100 cP com partículas de até 1.5mm de diâmetro.

É possível amostrar produtos mais viscosos, porém com maior tempo de ciclo de amostragem, dependendo da pressão da linha.

Além da variedade de tipos de corpo e cabeça para as S10 também estão disponíveis três materiais diferentes de membranas: EPDM, Silicone e PTFE.

Acessórios como engates rápidos para conexão das linhas de CIP e SIP e adaptadores também estão disponíveis.

Tipos de indústrias:

Cervejaria, laticínios, farmacêutica, biotecnologia.

Aplicações típicas:

Produtos e ingredientes farmacêuticos, cerveja filtrada, cremes e loções, perfumes, leite, água, azeite de oliva.

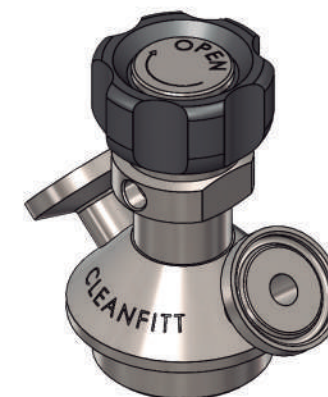

S5

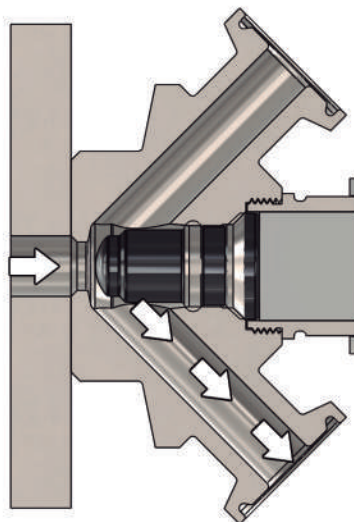



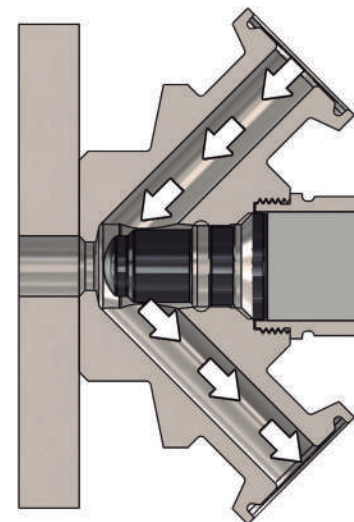

Amostragem















Esterilização

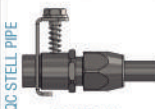

	Corpos para solda			Corpos para uniões			
	Solda em tanque	Solda em tubo	Solda em tubo NW 25		Mini Clamp	Clamp 1" e 1-1/2"	
CORPOS S5	Engate rápido						
		500001	500011	500014		500021	500022

CABEÇAS S5		Tipo TK Manípulo Giratório 0-6 bar
	Silicone	 510041
	EPDM	 510041E
	PTFE	 545541



ACESSÓRIOS S 5	Anéis	10.3x2.4 SILICONE  300830	10.3x2.4 EPDM  300830E	7.1x1.6 SILICONE  200825									
	Membranas	SILICONE  530051	EPDM  530052	PTFE  540055									
	Engate Rápido	PTFE QC 1.0m  950003	PTFE QC 0.5m  950002	RUBBER CAP  950062	QC HOSEBARB 3/8  950082	QC TC  950083	QC S10 W/ S5 HP  950086	QC PLUG  950061	QC STEEL PIPE  950070	COIL  950058	QC PTFE  950091		
	Para Cabeças de Válvulas	TOMMY BAR  960018											
	Diversos	CORRENTE AÇO INOX  550064	TUBO PTFE 10/8  950047	PTFE QC/TC 0.5m  95002.2	PTFE QC/TC 1.0m  950003.2								

Standard



Válvula de amostragem Cleanfitt Standard S15

CLEANFITT 
O sistema de amostragem estéril da Stockval

Esterilizável com vapor ou CIP, apresenta design Coaxial com uma entrada dedicada para SIP e CIP

A Cleanfitt Standard S15 foi projetada para amostrar produtos de altas viscosidades entre (0 e 50.000 cP) com presença de partículas de até 8 mm de diâmetro.

É possível inclusive amostrar produtos mais viscosos, apenas levando mais tempo para finalizar o ciclo de amostra (dependendo da pressão da linha).

Além da variedade de tipos de corpo e cabeça para as S15 também estão disponíveis membranas de PTFE.

Tipos de indústrias:

Cervejaria, laticínios, farmacêutica, biotecnologia.

Aplicações típicas:

logurte, mel, xaropes, ketchup, marmeladas, cremes e loções, produtos com polpa de frutas.



S15

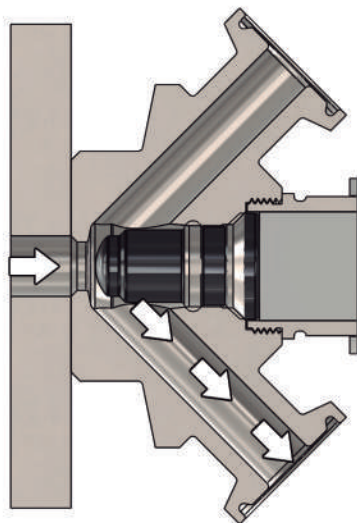



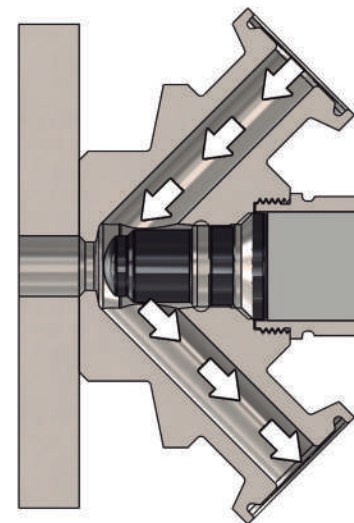





Amostragem



Esterilização



	Corpos para solda		Corpos para uniões			
	Solda em tanque	Solda em tubo	Varivent Ø68	Clamp 1"	Clamp 2"	Clamp 3"
CORPOS S15 Tri-clamp ¾"	 S15001	 S15011	 S15009	 S15004	 S15002	 S15003
Solda ¾"	 S15007					

CABEÇAS S15		Tipo TK Manipulo Giratório 0-10bar	Tipo TKS Manipulo (s/ mola) Giratório 0-12 bar
	PTFE	 155541	 155547

Esterilizável com vapor ou CIP, apresenta design Coaxial com uma entrada dedicada para SIP e CIP

A Cleanfitt Standard S25 é a maior válvula da linha Standard. Foi projetada para amostrar produtos de viscosidades muito altas, entre (0 e 250.000 cP) com presença de partículas de até 17 mm de diâmetro.

É possível inclusive amostrar produtos mais viscosos, apenas levando mais tempo para finalizar o ciclo de amostra (dependendo da pressão da linha).

Além da variedade de tipos de corpo e cabeça para as S25 também estão disponíveis membranas de PTFE.

Tipos de indústrias:

Cervejaria, laticínios, farmacêutica, biotecnologia.

Aplicações típicas:

Manteiga de amendoim, polpas de frutas, xaropes, produtos dom pedaços de frutas, cosméticos.



S25

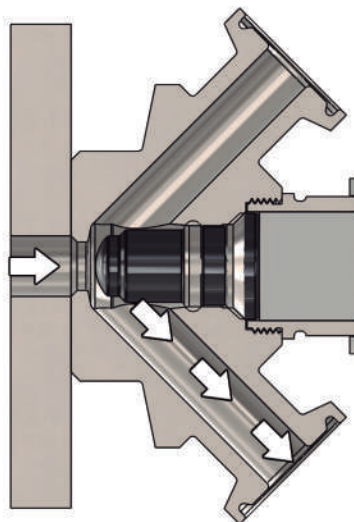



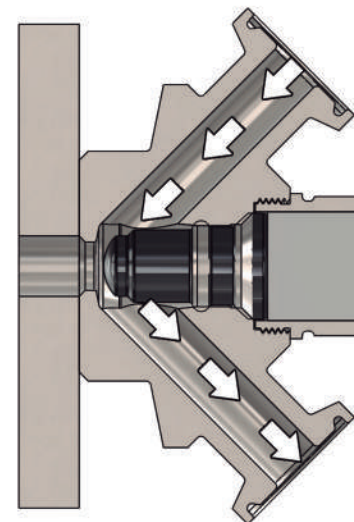

Amostragem





Esterilização



	Corpos para solda			Corpos para uniões		
	Solda em tanque			Varivent Ø68	Clamp 3"	
CORPOS S25	Tri-clamp 1"					
		S25001			S25009	S25003
	Solda					

CABEÇAS S25		Tipo TKS Manipulo Giratório (s/ mola) 0-12 bar
	PTFE	
		255547



ACESSÓRIOS S 25	Anéis	EPDM 60X3  100208																		
	Membranas	PTFE  250055																		
	Para Cabeças de Válvulas																			
	Diversos																			

Single
Access

Cleanfitt Single-Access

Substitua sua torneira de amostra tradicional, não higiênica, por uma válvula Cleanfitt Single-Access higiênica.

O design Single-Access da Cleanfitt é intercambiável com diversos sistemas disponíveis no mercado e possibilita ciclo de CIP passando pela válvula no local de sua instalação.

CLEANFITT 
O sistema de amostragem estéril da Stockval

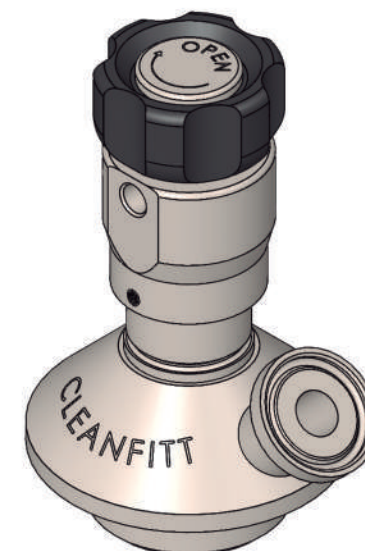

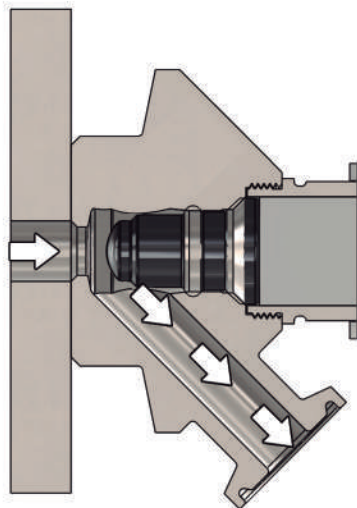

Amostragem

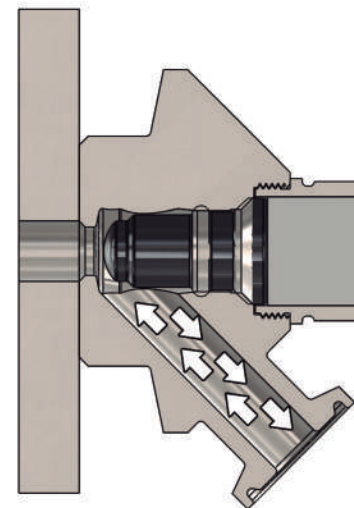

Esterilização

A Cleanfitt Single-Access SA10 é utilizada para aplicações com demandas menos restritivas, mas que ainda requerem passagem de ciclo de CIP pela válvula no local de instalação.

Caso a SA5 não atenda à aplicação devido a ser menor, a passagem livre de 9 mm da SA10 será adequada.

Utilizando a SA10 por favor, verifique a linha S10 para as cabeças de válvulas, já que utilizam as mesmas e lembre-se também de aproveitar a vantagem da possibilidade de utilização de diversos acessórios disponíveis para a linha S10.

Projetada para amostrar produtos com viscosidades entre 0 e 1.000 cP com presença de partículas de até 3 mm de diâmetro.

Tipos de indústrias:

Cervejaria, laticínios, farmacêutica, biotecnologia.

Aplicações típicas:



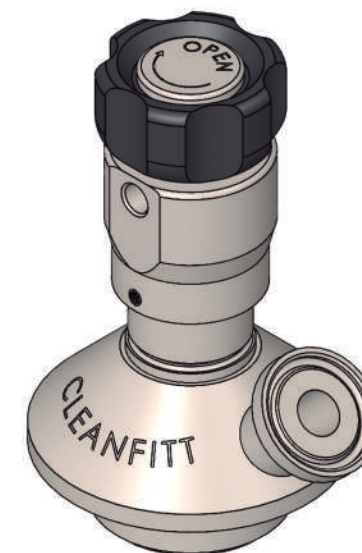

Água, leite, perfumes, sucos de frutas.



Single-Access SA10

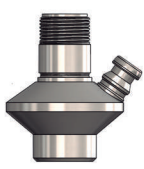

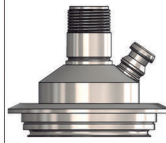
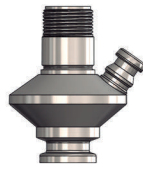
Cleanfitt Single-Access SA10 - CORPOS

	Corpos para solda		Corpos para uniões				
	Solda em tanque	Solda em tubo	Varivent Ø50	Varivent Ø68	Mini Clamp	Clamp 1" e 1-1/2"	
CORPOS SA10	Engate rápido	 9A0001	 9A0011	 9A0008	 9A0009	 9A0036	 9A0021
	Tri-clamp 1/2"						

Standard



Válvula de amostragem Cleanfitt Single-Access SA5

CLEANFITT 
O sistema de amostragem estéril da Stockval

A Cleanfitt Single-Access SA5 é utilizada para aplicações com demandas menos restritivas, mas que ainda requerem passagem de ciclo de CIP pela válvula no local de instalação.

Projetada para amostrar produtos com viscosidades entre 0 e 1.00 cP com presença de partículas de até 1.5 mm de diâmetro.

Oferecida em montagem completa (corpo + cabeça) diferentemente das outras válvulas da linha Cleanfitt.

Tipos de indústrias:

cervejaria, laticínios, farmacêutica, biotecnologia.

Aplicações típicas:

água, leite, perfumes, sucos de frutas.

Membranas disponíveis:

silicone, EPDM e PTFE.

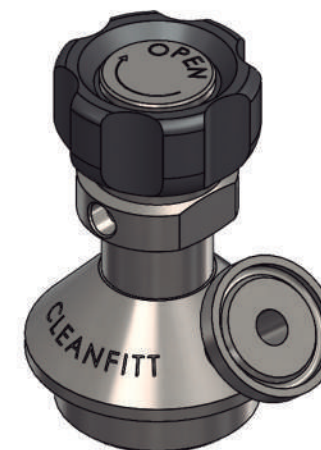

Single-Access SA5

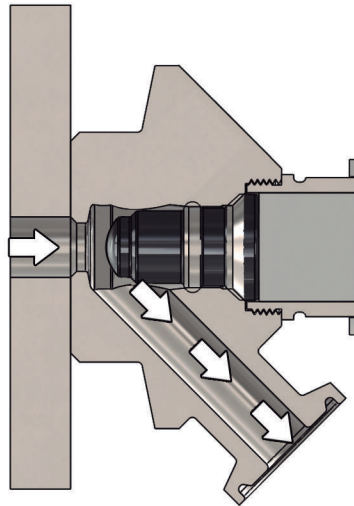

Amostragem

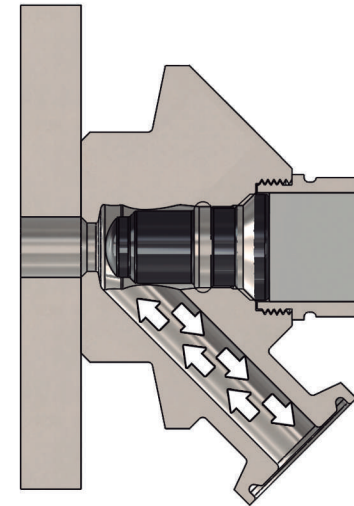















Esterilização

Standard



















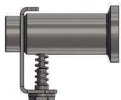
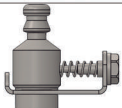
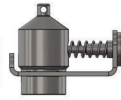
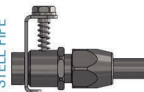

Cleanfitt Single-Access SA5

CLEANFIT[®]
O sistema de amostragem estéril da Stockval

		Solda em tanque	Solda em tubo	Mini Clamp	Clamp 1" e 1-1/2"
		Engate rápido			
CORPOS SA5	SILICONE	 5A0141	 5A1141	 5A2141	 5A2241
	EPDM	 5A0141E	 5A1141E	 5A2141E	 5A2241E
	PTFM	 5A0141P	 5A1141P	 5A2141P	 5A2241P



ACESSÓRIOS S A5	Anéis	7.1x1.6 SILICONE  200825	10.3x2.4 SILICONE  300830	10.3x2.4 SILICONE  300830E										
	Membranas	SILICONE  530051	EPDM  530052	PTFE  540055										
	Engate Rápido	PTFE QC 1.0m  950003	PTFE QC 0.5m  950002	RUBBER CAP  950062	QC HOSEBARB 3/8  950082	QC TC  950083	QC S10 W/ S5 HP  950086	QC PLUG  950061	QC STELL PIPE  950070	COIL  950058	QC PTFE  950091			
	Diversos	TOMMY BAR  960018												
		CORRENTE AÇO INOX  550064	TUBO PTFE 10/8  950047	PTFE QC/TC 0.5m  95002.2	PTFE QC/TC 1.0m  950003.2									

Micro
Access

Cleanfitt Micro-Access

O Cleanfitt Micro-Access é uma membrana auto-vedável que permite a retirada de amostras via agulha hipodérmica com risco baixíssimo de contaminação.

Projetado para amostrar produtos com viscosidades baixas, entre 0 e 50 cP com presença de partículas de até 1.5 mm de diâmetro.

De fácil manutenção o Cleanfitt Micro-Access tem utilização super prática sendo a melhor escolha caso haja necessidade de amostrar via agulha/seringa.

Tipos de indústrias:

Cervejaria, laticínios, farmacêutica, biotecnologia.

Aplicações típicas:

Água, produtos e ingredientes farmacêuticos, leite, cerveja filtrada, perfumes, azeite de oliva.



Micro-Access

Standard







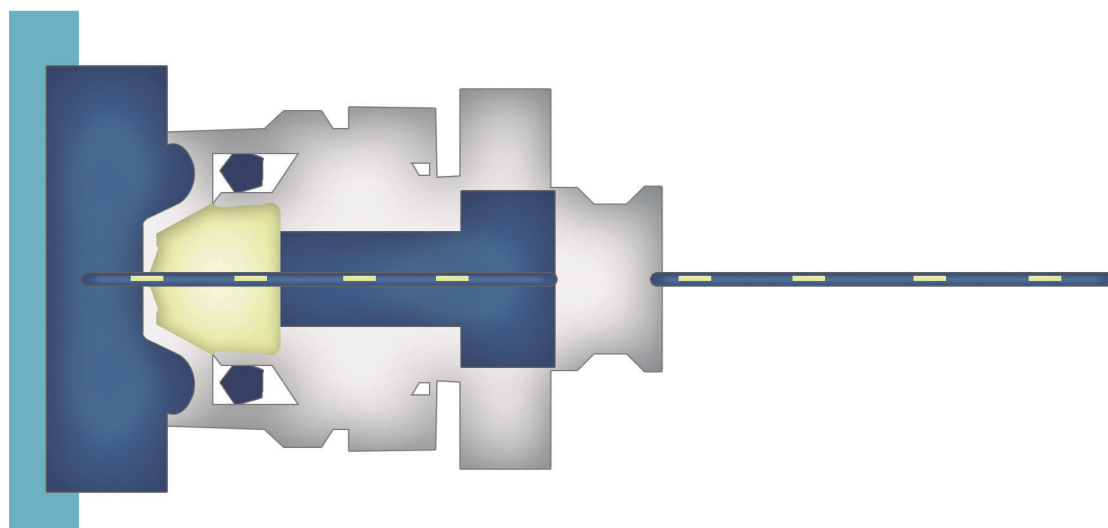

Funcionamento

CLEANFITT 
O sistema de amostragem estéril da Stockval





		Corpos para Solda				Corpos para Uniões		
		Tanque	Solda em tanque 1"	Solda em tubo NW25	Varivente Ø50	Varivente Ø68	Mini Clamp	Clamp 1
Micro-Access	Membrana Butyl (IIR)							
		MA0056	MA0057	MA0014	MA0027	MA0028	MA0059	MA0058



Stockval Tecno Comercial Ltda. Rua da Paz, 1.557
04713-002 - São Paulo - SP - Fone: 55 11 5106-3444
stockval@stockval.com.br www.stockval.com.br

